

|           |  |
|-----------|--|
| PROJECT   |  |
| TYPE      |  |
| SPECIFIER |  |
| QUANTITY  |  |
| DATE      |  |

## BIONIQ ROUND ADJUSTABLE TRIMLESS

### A35179-

|             |             |                   |                    |                   |                   |
|-------------|-------------|-------------------|--------------------|-------------------|-------------------|
| base number | LED Dimming | Color Temperature | Finishes (Diamond) | Ceiling Thickness | Reflector Options |
|-------------|-------------|-------------------|--------------------|-------------------|-------------------|

- To build a product code in our configurator select the specify button on the base model # product page
- To build a manual product code on this datasheet choose from the options listed below in blue font and add the suffix to the base model #

#### GENERAL

Series: Bioniq  
 Subseries: Bioniq Round Adjustable  
 Brand: Prolicht  
 Division: Architectural  
 Mounting Type: Trimless  
 Mounting Location: Ceiling  
 Subcategory: Downlight

#### PHYSICAL

Shape: Round  
 Diameter (mm): 107  
 Diameter (in): 4 3/16  
 Height (mm): 112  
 Height (in): 4 7/16  
 Ceiling Thickness (mm): 10 / 12.5 / 15 / 25  
 Ceiling Thickness (in): 3/8 or 1/2 or 9/16 or 1  
 Min. Recessing Depth (mm): 130  
 Min. Recessing Depth (in): 5 1/8  
 Light Distribution: Adjustable / Downlight  
 Weight (kg): 0.557  
 Weight (lbs): 1.227  
 Fixture Finish: SSR / BKV / CWI / CRY / HAB / UFT / ITA / RUA / FTG / MYG / LOD / PUS / FRO / FUP / KIA / POP / BLS / SPG / MEY / GOH / GUM / CHC / COM / ABZ / JAG / OBR / MOS / ROR  
 Fixture Material: Aluminum Die Cast  
 Cut-out Measurements: Ø 111mm / 4 3/8"  
 Upon Request: Unique Ceiling Thickness

#### ELECTRICAL

Lamp Type: LED (Zhaga Standard)  
 Input Wattage (W): 15.5  
 Total Output Wattage (W): 14.5  
 Dimming: Tri-Mode (Non-Dimming and Phase Dimming (120Vac only) and 0-10V Dimming)  
 Driver Included: No  
 Driver Location: Recessed Housing  
 Driver Type: Constant Current - Universal  
 Driver Class: Class 2  
 Housing: See components  
 Input Voltage (V): 120 - 277  
 Constant Current (MA): 500

#### LED

Number of LEDs: 1  
 Color Temperature (°K): 2700 / 3000 / 3500 / 4000  
 Max. Delivered Lumen (lm): 940 / 980 / 1029 / 1050  
 CRI: >90 CRI  
 Efficiency (%): 87.9 / 88.4 / 87.9 / 87.9  
 Lamp Life (hrs): 50000  
 Upon Request: RGB-W Tunable White Special Color Temperature Special LED

#### OPTICAL

Reflector: 20 / 40 / 60  
 Adjustability: Rotational 355°; Tilt 30°  
 Upon Request: Special Beam Angles

#### RATINGS AND CERTIFICATIONS

Certified By: Certified for North American Standards  
 Zaneen Group Inc. © 2024, T 1800-388-3382, F 416-247-9319, www.zaneen.com  
 IP Rating: IP20  
 Available for international specifications by adding "INT" at the end of the existing Model #. For assistance on 'custom' specifications, contact zteam@zaneen.com.  
 In a constant effort to supply the best product, we reserve the right to change specifications or materials without notice. The most recent specification sheets are found at zaneen.com



## BIONIQ ROUND ADJUSTABLE TRIMLESS

A35179-

|           |
|-----------|
| PROJECT   |
| TYPE      |
| SPECIFIER |
| QUANTITY  |
| DATE      |



## BIONIQ ROUND ADJUSTABLE TRIMLESS

### A35182-

base number LED Dimming Color Temperature Finishes (Diamond) Ceiling Thickness

- To build a product code in our configurator select the specify button on the base model # product page
- To build a manual product code on this datasheet choose from the options listed below in blue font and add the suffix to the base model #

#### GENERAL

Series: Bioniq  
 Subseries: Bioniq Round Adjustable  
 Brand: Prolicht  
 Division: Architectural  
 Mounting Type: Trimless  
 Mounting Location: Ceiling  
 Subcategory: Downlight

#### PHYSICAL

Shape: Round  
 Diameter (mm): 107  
 Diameter (in): 4 3/16  
 Height (mm): 112  
 Height (in): 4 7/16  
 Ceiling Thickness (mm): 10 / 12.5 / 15 / 25  
 Ceiling Thickness (in): 3/8 or 1/2 or 9/16 or 1  
 Min. Recessing Depth (mm): 130  
 Min. Recessing Depth (in): 5 1/8  
 Light Distribution: Adjustable / Downlight  
 Weight (kg): 0.596  
 Weight (lbs): 1.31  
 Fixture Finish: SSR / BKV / CWI / CRY / HAB / UFT / ITA / RUA / FTG / MYG / LOD / PUS / FRO / FUP / KIA / POP / BLS / SPG / MEY / GOH / GUM / CHC / COM / ABZ / JAG / OBR / MOS / ROR  
 Fixture Material: Aluminum Die Cast  
 Cut-out Measurements: Ø 111mm / 4 3/8"  
 Upon Request: Unique Ceiling Thickness

#### ELECTRICAL

Lamp Type: LED (Zhaga Standard)  
 Input Wattage (W): 13.2 / 16.5  
 Total Output Wattage (W): 12.1 / 14.7  
 Dimming: Tri-Mode (Non-Dimming and Phase Dimming (120Vac only) and 0-10V Dimming)  
 Driver Included: No  
 Driver Location: Recessed Housing  
 Driver Type: Constant Current - Universal  
 Driver Class: Class 2  
 Housing: See components  
 Input Voltage (V): 120 - 277  
 Constant Current (MA): 350

#### LED

Number of LEDs: 1  
 Color Temperature (°K): 2700 / 3000 / 3500 / 4000  
 Max. Delivered Lumen (lm): 850 / 950 / 1019 / 1040  
 Nominal Lumen (lm): 960 / 1070 / 1156 / 1180  
 CRI: >90 CRI  
 Lamp Life (hrs): 50000  
 Upon Request: RGB-W Tunable White Special Color Temperature Special LED

#### OPTICAL

Reflector: 10  
 Adjustability: Rotational 355°; Tilt 30°  
 Upon Request: Special Beam Angles

#### RATINGS AND CERTIFICATIONS

Certified By: Certified for North American Standards  
 Zaneen Group Inc. © 2024, T 1800-388-3382, F 416-247-9319, www.zaneen.com  
 IP Rating: IP20  
 Available for International specifications by adding "INT" at the end of the existing Model #. For assistance on 'custom' specifications, contact zteam@zaneen.com.  
 In a constant effort to supply the best product, we reserve the right to change specifications or materials without notice. The most recent specification sheets are found at zaneen.com



## BIONIQ ROUND ADJUSTABLE TRIMLESS

A35182-

PROJECT

TYPE

SPECIFIER

QUANTITY

DATE



## BIONIQ ROUND ADJUSTABLE TRIMLESS

### A35185-

base number LED Dimming Color Temperature Finishes (Diamond) Ceiling Thickness Reflector Options

- To build a product code in our configurator select the specify button on the base model # product page
- To build a manual product code on this datasheet choose from the options listed below in blue font and add the suffix to the base model #

#### GENERAL

Series: Bioniq  
 Subseries: Bioniq Round Adjustable  
 Brand: Prolicht  
 Division: Architectural  
 Mounting Type: Trimless  
 Mounting Location: Ceiling  
 Subcategory: Downlight

#### PHYSICAL

Shape: Round  
 Diameter (mm): 136  
 Diameter (in): 5 3/8  
 Height (mm): 136  
 Height (in): 5 3/8  
 Ceiling Thickness (mm): 10 / 12.5 / 15 / 25  
 Ceiling Thickness (in): 3/8 or 1/2 or 9/16 or 1  
 Min. Recessing Depth (mm): 150  
 Min. Recessing Depth (in): 5 7/8  
 Light Distribution: Adjustable / Downlight  
 Weight (kg): 1.024  
 Weight (lbs): 2.25  
 Fixture Finish: SSR / BKV / CWI / CRY / HAB / UFT / ITA / RUA / FTG / MYG / LOD / PUS / FRO / FUP / KIA / POP / BLS / SPG / MEY / GOH / GUM / CHC / COM / ABZ / JAG / OBR / MOS / ROR  
 Fixture Material: Aluminum Die Cast  
 Cut-out Measurements: 140mm / 5 1/2"  
 Upon Request: Unique Ceiling Thickness

#### ELECTRICAL

Lamp Type: LED (Zhaga Standard)  
 Input Wattage (W): 28.6  
 Total Output Wattage (W): 26.4  
 Dimming: Tri-Mode (Non-Dimming and Phase Dimming (120Vac only) and 0-10V Dimming)  
 Driver Included: No  
 Driver Location: Recessed Housing  
 Driver Type: Constant Current - Universal  
 Driver Class: Class 2  
 Housing: See components  
 Input Voltage (V): 120 - 277  
 Constant Current (MA): 700

#### LED

Number of LEDs: 1  
 Color Temperature (°K): 2700 / 3000 / 3500 / 4000  
 Max. Delivered Lumen (lm): 2030 / 2080 / 2185 / 2230  
 Nominal Lumen (lm): 3210 / 3290 / 3459 / 3530  
 CRI: >90 CRI  
 Efficiency (%): 63.1 / 61.5 / 63.2  
 Lamp Life (hrs): 50000  
 Upon Request: RGB-W Tunable White Special Color Temperature Special LED

#### OPTICAL

Reflector°: 20 / 25 / 40  
 Adjustability: Rotational 355°; Tilt 30°  
 Upon Request: Special Beam Angles

#### RATINGS AND CERTIFICATIONS

Zaneen Group Inc. © 2024, T 1800-388-3382, F 416-247-9319, www.zaneen.com  
 Certified By: Certified for North American Standards  
 Available for International specifications by adding "INT" at the end of the existing Model #. For assistance on 'custom' specifications, contact zteam@zaneen.com.  
 IP Rating: IP20  
 If a conflict occurs to supply the best product, we reserve the right to change specifications or materials without notice. The most recent specification sheets are found at zaneen.com



Ø 136mm 5 3/8"

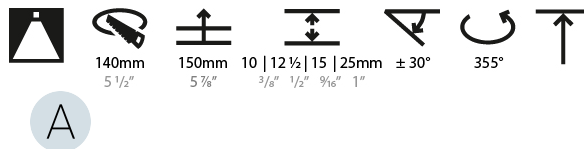

## BIONIQ ROUND ADJUSTABLE TRIMLESS

A35185-

PROJECT

TYPE

SPECIFIER

QUANTITY

DATE



|           |       |
|-----------|-------|
| PROJECT   | _____ |
| TYPE      | _____ |
| SPECIFIER | _____ |
| QUANTITY  | _____ |
| DATE      | _____ |

## BIONIQ ROUND ADJUSTABLE TRIMLESS

### A35188-

|             |                |                      |                       |                      |
|-------------|----------------|----------------------|-----------------------|----------------------|
| base number | LED<br>Dimming | Color<br>Temperature | Finishes<br>(Diamond) | Ceiling<br>Thickness |
|-------------|----------------|----------------------|-----------------------|----------------------|

- To build a product code in our configurator select the specify button on the base model # product page
- To build a manual product code on this datasheet choose from the options listed below in blue font and add the suffix to the base model #

#### GENERAL

Series: Bioniq  
 Subseries: Bioniq Round Adjustable  
 Brand: Prolicht  
 Division: Architectural  
 Mounting Type: Trimless  
 Mounting Location: Ceiling  
 Subcategory: Downlight

#### PHYSICAL

Shape: Round  
 Diameter (mm): 136  
 Diameter (in): 5 3/8  
 Height (mm): 136  
 Height (in): 5 3/8  
 Ceiling Thickness (mm): 10 / 12.5 / 15 / 25  
 Ceiling Thickness (in): 3/8 or 1/2 or 9/16 or 1  
 Min. Recessing Depth (mm): 150  
 Min. Recessing Depth (in): 5 7/8  
 Light Distribution: Adjustable / Downlight  
 Weight (kg): 1.02  
 Weight (lbs): 2.24  
 Fixture Finish: SSR / BKV / CWI / CRY / HAB / UFT / ITA / RUA / FTG / MYG / LOD / PUS / FRO / FUP / KIA / POP / BLS / SPG / MEY / GOH / GUM / CHC / COM / ABZ / JAG / OBR / MOS / ROR  
 Fixture Material: Aluminum Die Cast  
 Cut-out Measurements: Ø 140mm / 5 1/2"  
 Upon Request: Unique Ceiling Thickness

#### ELECTRICAL

Lamp Type: LED (Zhaga Standard)  
 Input Wattage (W): 13.2 / 16.5  
 Total Output Wattage (W): 12.1 / 14.7  
 Dimming: Tri-Mode (Non-Dimming and Phase Dimming (120Vac only) and 0-10V Dimming)  
 Driver Included: No  
 Driver Location: Recessed Housing  
 Driver Type: Constant Current - Universal  
 Driver Class: Class 2  
 Housing: See components  
 Input Voltage (V): 120 - 277  
 Constant Current (MA): 350

#### LED

Number of LEDs: 1  
 Color Temperature (°K): 2700 / 3000 / 3500 / 4000  
 Max. Delivered Lumen (lm): 870 / 970 / 1038 / 1060  
 Nominal Lumen (lm): 960 / 1070 / 1156 / 1180  
 CRI: >90 CRI  
 Efficiency (%): 90.5  
 Lamp Life (hrs): 50000  
 Upon Request: RGB-W Tunable White Special Color Temperature Special LED

#### OPTICAL

Reflector: 10  
 Beam Angle: Narrow  
 Adjustability: Rotational 355°; Tilt 30°  
 Upon Request: Special Beam Angles

#### RATINGS AND CERTIFICATIONS

382, F 416-247-9319, www.zaneen.com  
 Certified by Intertek for North American Standards. At the end of the existing Model #. For assistance on 'custom' specifications, contact zteam@zaneen.com.  
 In a constant effort to supply the best product, we reserve the right to change specifications or materials without notice. The most recent specification sheets are found at zaneen.com  
 IP rating: IP20

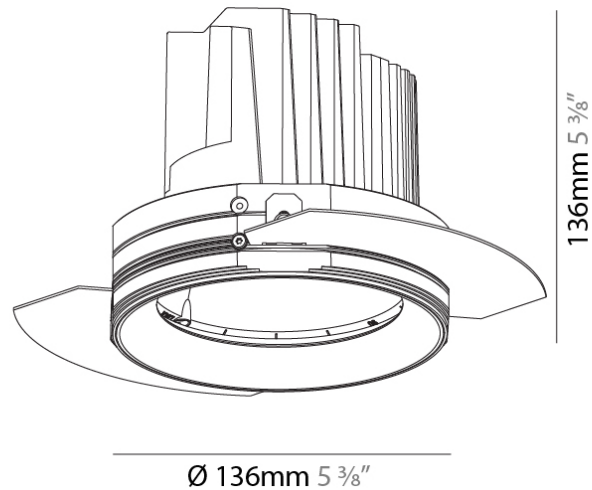

140mm 5 1/2"  
 150mm 5 3/8"  
 10 | 12 1/2 | 15 | 25mm 3/8" 1/2" 9/16" 1"  
 ± 30° 355°

A

## BIONIQ ROUND ADJUSTABLE TRIMLESS

A35188-

PROJECT

TYPE

SPECIFIER

QUANTITY

DATE

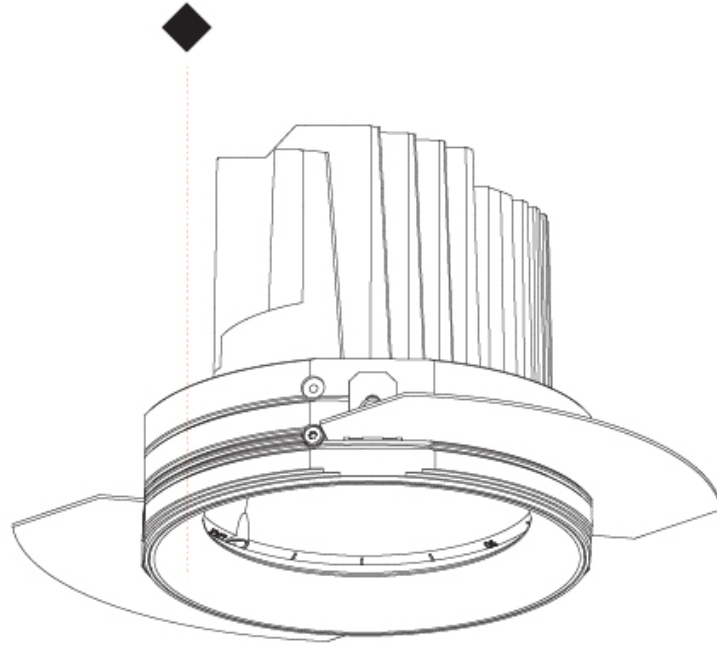

A



|           |
|-----------|
| PROJECT   |
| TYPE      |
| SPECIFIER |
| QUANTITY  |
| DATE      |

## BIONIQ ROUND DEEP TRIMLESS

### A35191-

|             |                   |                    |                   |                   |              |
|-------------|-------------------|--------------------|-------------------|-------------------|--------------|
| base number | Color Temperature | Finishes (Diamond) | Ceiling Thickness | Reflector Options | Lens Options |
|-------------|-------------------|--------------------|-------------------|-------------------|--------------|

- To build a product code in our configurator select the specify button on the base model # product page
- To build a manual product code on this datasheet choose from the options listed below in blue font and add the suffix to the base model #

#### GENERAL

|                              |
|------------------------------|
| Series: Bioniq               |
| Subseries: Bioniq Round Deep |
| Brand: Prolicht              |
| Division: Architectural      |
| Mounting Type: Trimless      |
| Mounting Location: Ceiling   |
| Subcategory: Downlight       |

#### PHYSICAL

|   |
|---|
| Shape: Round  |
| Diameter (mm): 107  |
| Diameter (in): 4 3/16   |
| Height (mm): 130  |
| Height (in): 5 1/8  |
| Ceiling Thickness (mm): 10 / 12.5 / 15 / 25   |
| Ceiling Thickness (in): 3/8 or 1/2 or 9/16 or 1   |
| Min. Recessing Depth (mm): 150  |
| Min. Recessing Depth (in): 5 7/8  |
| Light Distribution: Downlight   |
| Weight (kg): 0.646  |
| Weight (lbs): 1.42  |
| Fixture Finish: SSR / BKV / CWI / CRY / HAB / UFT / ITA / RUA / FTG / MYG / LOD / PUS / FRO / FUP / KIA / POP / BLS / SPG / MEY / GOH / GUM / CHC / COM / ABZ / JAG / OBR / MOS / ROR |
| Fixture Material: Aluminum Die Cast   |
| Cut-out Measurements: Ø 111mm / 4 3/8"  |
| Upon Request: Unique Ceiling Thickness  |

#### ELECTRICAL

|   |
|---|
| Lamp Type: LED (Zhaga Standard)   |
| Input Wattage (W): 13   |
| Total Output Wattage (W): 11.8  |
| Dimming: Tri-Mode (Non-Dimming and Phase Dimming (120Vac only) and 0-10V Dimming) |
| Driver Included: No   |
| Driver Location: Recessed Housing   |
| Driver Type: Constant Current - Universal   |
| Driver Class: Class 2   |
| Housing: See components   |
| Input Voltage (V): 120 - 277  |
| Constant Current (MA): 350  |

#### LED

|   |
|---|
| Number of LEDs: 1   |
| Color Temperature (°K): 2700 / 3000 / 3500 / 4000                       |
| Max. Delivered Lumen (lm): 876 / 909 / 955 / 974                        |
| Nominal Lumen (lm): 1304 / 1352 / 1421 / 1450                           |
| CRI: >90 CRI  |
| Efficiency (%): 87.9 / 88.4 / 87.9                                      |
| Lamp Life (hrs): 50000  |
| Upon Request: RGB-W Tunable White Special Color Temperature Special LED |

#### OPTICAL

|  |
|--|
| Reflector°: 18 / 42 / 60   |
| Optic°: Lens Pack - No Lens / Linear Spread Lens / Honeycomb / Spread Lens |
| Upon Request: Special Beam Angles  |

#### RATINGS AND CERTIFICATIONS

382, F 416-247-9319, www.zaneen.com

Created by Interchange for North American Standards at the end of the existing Model #. For assistance on 'custom' specifications, contact zteam@zaneen.com. In a constant effort to supply the best product, we reserve the right to change specifications or materials without notice. The most recent specification sheets are found at zaneen.com

IP rating: IP20

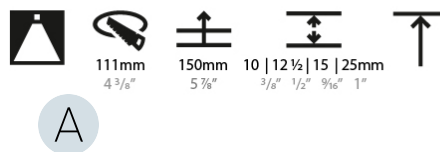
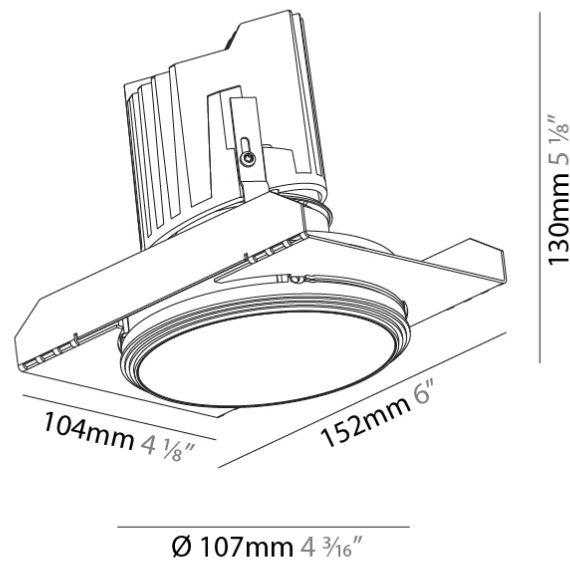

## BIONIQ ROUND DEEP TRIMLESS

A35191-

PROJECT

TYPE

SPECIFIER

QUANTITY

DATE



|           |       |
|-----------|-------|
| PROJECT   | _____ |
| TYPE      | _____ |
| SPECIFIER | _____ |
| QUANTITY  | _____ |
| DATE      | _____ |

## BIONIQ ROUND DEEP TRIMLESS

### A35194-

|             |                      |                       |                      |                      |                 |
|-------------|----------------------|-----------------------|----------------------|----------------------|-----------------|
| base number | Color<br>Temperature | Finishes<br>(Diamond) | Ceiling<br>Thickness | Reflector<br>Options | Lens<br>Options |
|-------------|----------------------|-----------------------|----------------------|----------------------|-----------------|

- To build a product code in our configurator select the specify button on the base model # product page
- To build a manual product code on this datasheet choose from the options listed below in blue font and add the suffix to the base model #

#### GENERAL

Series: Bioniq  
 Subseries: Bioniq Round Deep  
 Brand: Prolicht  
 Division: Architectural  
 Mounting Type: Trimless  
 Mounting Location: Ceiling  
 Subcategory: Downlight

#### PHYSICAL

Shape: Round  
 Diameter (mm): 136  
 Diameter (in): 5 3/8  
 Height (mm): 151  
 Height (in): 5 15/16  
 Ceiling Thickness (mm): 10 / 12.5 / 15 / 25  
 Ceiling Thickness (in): 3/8 or 1/2 or 9/16 or 1  
 Min. Recessing Depth (mm): 170  
 Min. Recessing Depth (in): 6 11/16  
 Light Distribution: Downlight  
 Weight (kg): 1.078  
 Weight (lbs): 2.37  
 Fixture Finish: SSR / BKV / CWI / CRY / HAB / UFT / ITA / RUA / FTG / MYG / LOD / PUS / FRO / FUP / KIA / POP / BLS / SPG / MEY / GOH / GUM / CHC / COM / ABZ / JAG / OBR / MOS / ROR  
 Fixture Material: Aluminum Die Cast  
 Cut-out Measurements: Ø 140mm / 5 1/2"  
 Upon Request: Unique Ceiling Thickness

#### ELECTRICAL

Lamp Type: LED (Zhaga Standard)  
 Input Wattage (W): 28  
 Total Output Wattage (W): 26.4  
 Dimming: Tri-Mode (Non-Dimming and Phase Dimming (120Vac only) and 0-10V Dimming)  
 Driver Included: No  
 Driver Location: Recessed Housing  
 Driver Type: Constant Current - Universal  
 Driver Class: Class 2  
 Housing: See components  
 Input Voltage (V): 120 - 277  
 Constant Current (MA): 700

#### LED

Number of LEDs: 1  
 Color Temperature (°K): 2700 / 3000 / 3500 / 4000  
 Max. Delivered Lumen (lm): 2156 / 2244 / 2377 / 2425  
 Nominal Lumen (lm): 2909 / 3028 / 3208 / 2373  
 CRI: >90 CRI  
 Lamp Life (hrs): 50000  
 Upon Request: RGB-W Tunable White Special Color Temperature Special LED

#### OPTICAL

Reflector°: 18 / 34  
 Optic°: Lens Pack - No Lens / Linear Spread Lens / Honeycomb / Spread Lens  
 Adjustability: Fixed  
 Upon Request: Special Beam Angles

#### RATINGS AND CERTIFICATIONS

382, F 416-247-9319, www.zaneen.com  
 Certified by Intertek for North American standards at the end of the existing Model #. For assistance on 'custom' specifications, contact zteam@zaneen.com.  
 In a constant effort to supply the best product, we reserve the right to change specifications or materials without notice. The most recent specification sheets are found at zaneen.com  
 IP rating: IP20

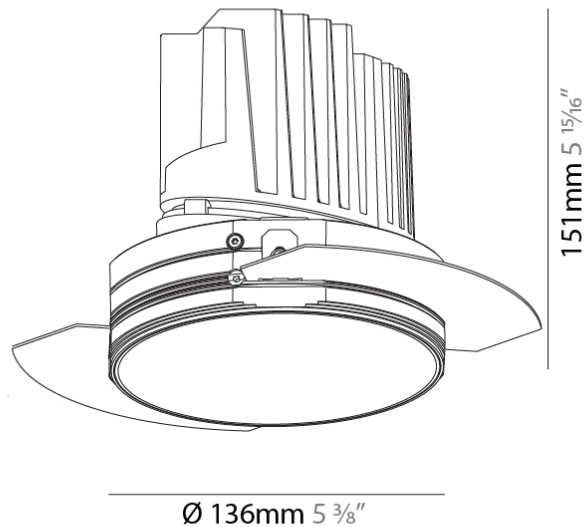

## BIONIQ ROUND DEEP TRIMLESS

A35194-

PROJECT

TYPE

SPECIFIER

QUANTITY

DATE

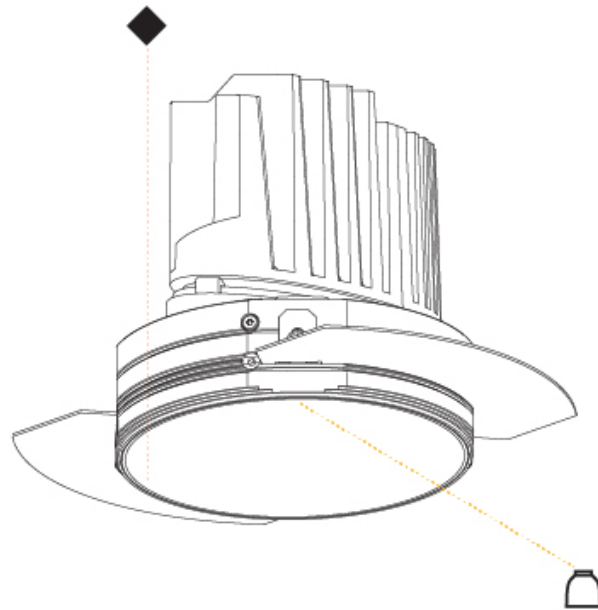

A

|           |  |
|-----------|--|
| PROJECT   |  |
| TYPE      |  |
| SPECIFIER |  |
| QUANTITY  |  |
| DATE      |  |

## BIONIQ ROUND DEEP TRIMLESS

### A35197-

|             |                      |                       |                      |                 |
|-------------|----------------------|-----------------------|----------------------|-----------------|
| base number | Color<br>Temperature | Finishes<br>(Diamond) | Ceiling<br>Thickness | Lens<br>Options |
|-------------|----------------------|-----------------------|----------------------|-----------------|

- To build a product code in our configurator select the specify button on the base model # product page
- To build a manual product code on this datasheet choose from the options listed below in blue font and add the suffix to the base model #

#### GENERAL

|                              |
|------------------------------|
| Series: Bioniq               |
| Subseries: Bioniq Round Deep |
| Brand: Prolicht              |
| Division: Architectural      |
| Mounting Type: Trimless      |
| Mounting Location: Ceiling   |
| Subcategory: Downlight       |

#### PHYSICAL

|   |
|---|
| Shape: Round  |
| Diameter (mm): 136  |
| Diameter (in): 5 3/8  |
| Height (mm): 151  |
| Height (in): 5 15/16  |
| Ceiling Thickness (mm): 10 / 12.5 / 15 / 25   |
| Ceiling Thickness (in): 3/8 or 1/2 or 9/16 or 1   |
| Min. Recessing Depth (mm): 170  |
| Min. Recessing Depth (in): 6 11/16  |
| Light Distribution: Downlight   |
| Weight (kg): 1.073  |
| Weight (lbs): 2.36  |
| Fixture Finish: SSR / BKV / CWI / CRY / HAB / UFT / ITA / RUA / FTG / MYG / LOD / PUS / FRO / FUP / KIA / POP / BLS / SPG / MEY / GOH / GUM / CHC / COM / ABZ / JAG / OBR / MOS / ROR |
| Fixture Material: Aluminum Die Cast   |
| Cut-out Measurements: $\varnothing$ 140mm / 5 1/2"  |
| Upon Request: Unique Ceiling Thickness  |

#### ELECTRICAL

|   |
|---|
| Lamp Type: LED (Zhaga Standard)   |
| Input Wattage (W): 13.2 / 16.5  |
| Total Output Wattage (W): 12.1 / 14.7   |
| Dimming: Tri-Mode (Non-Dimming and Phase Dimming (120Vac only) and 0-10V Dimming) |
| Driver Included: No   |
| Driver Location: Recessed Housing   |
| Driver Type: Constant Current - Universal   |
| Driver Class: Class 2   |
| Housing: See components   |
| Input Voltage (V): 120 - 277  |
| Constant Current (MA): 350  |

#### LED

|   |
|---|
| Number of LEDs: 1   |
| Color Temperature (°K): 2700 / 3000 / 3500 / 4000                       |
| Max. Delivered Lumen (lm): 814 / 877 / 911 / 930                        |
| Nominal Lumen (lm): 1246 / 1342 / 1396 / 1424                           |
| CRI: >90 CRI  |
| Efficiency (%): 90.5  |
| Lamp Life (hrs): 50000  |
| Upon Request: RGB-W Tunable White Special Color Temperature Special LED |

#### OPTICAL

|  |
|--|
| Reflector°: 10   |
| Optic°: Lens Pack - No Lens / Linear Spread Lens / Honeycomb / Spread Lens |
| Upon Request: Special Beam Angles  |

#### RATINGS AND CERTIFICATIONS

382, F 416-247-9319, www.zaneen.com  
 Certified by Intertek for North American standards. At the end of the existing Model #. For assistance on 'custom' specifications, contact zteam@zaneen.com.  
 In a constant effort to supply the best product, we reserve the right to change specifications or materials without notice. The most recent specification sheets are found at zaneen.com  
 IP rating: IP20

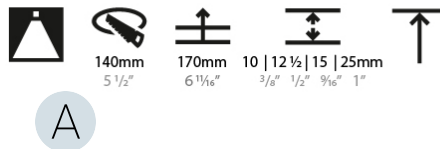
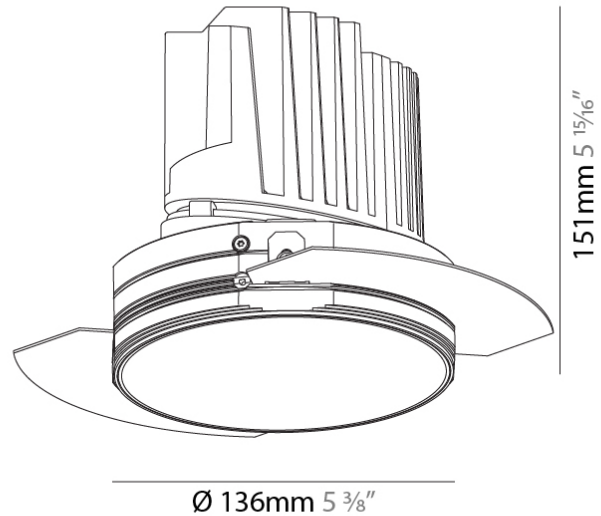

## BIONIQ ROUND DEEP TRIMLESS

A35197-

PROJECT

TYPE

SPECIFIER

QUANTITY

DATE



|           |  |
|-----------|--|
| PROJECT   |  |
| TYPE      |  |
| SPECIFIER |  |
| QUANTITY  |  |
| DATE      |  |

## BIONIQ ROUND SEMI ADJUSTABLE TRIMLESS

### A35200-

|             |             |                   |                    |                   |                   |
|-------------|-------------|-------------------|--------------------|-------------------|-------------------|
| base number | LED Dimming | Color Temperature | Finishes (Diamond) | Ceiling Thickness | Reflector Options |
|-------------|-------------|-------------------|--------------------|-------------------|-------------------|

- To build a product code in our configurator select the specify button on the base model # product page
- To build a manual product code on this datasheet choose from the options listed below in blue font and add the suffix to the base model #

#### GENERAL

|   |
|---|
| Series: Bioniq                          |
| Subseries: Bioniq Round Semi Adjustable |
| Brand: Prolicht                         |
| Division: Architectural                 |
| Mounting Type: Trimless                 |
| Mounting Location: Ceiling              |
| Subcategory: Downlight                  |

#### PHYSICAL

|   |
|---|
| Shape: Round  |
| Diameter (mm): 107  |
| Diameter (in): 4 3/16   |
| Height (mm): 112  |
| Height (in): 4 7/16   |
| Ceiling Thickness (mm): 10 / 12.5 / 15 / 25   |
| Ceiling Thickness (in): 3/8 or 1/2 or 9/16 or 1   |
| Min. Recessing Depth (mm): 130  |
| Min. Recessing Depth (in): 5 1/8  |
| Light Distribution: Adjustable / Downlight  |
| Weight (kg): 0.621  |
| Weight (lbs): 1.37  |
| Fixture Finish: SSR / BKV / CWI / CRY / HAB / UFT / ITA / RUA / FTG / MYG / LOD / PUS / FRO / FUP / KIA / POP / BLS / SPG / MEY / GOH / GUM / CHC / COM / ABZ / JAG / OBR / MOS / ROR |
| Fixture Material: Aluminum Die Cast   |
| Cut-out Measurements: $\square$ 111mm / 4 3/8"  |
| Upon Request: Unique Ceiling Thickness  |

#### ELECTRICAL

|   |
|---|
| Lamp Type: LED (Zhaga Standard)   |
| Input Wattage (W): 15.5   |
| Total Output Wattage (W): 14.5  |
| Dimming: Tri-Mode (Non-Dimming and Phase Dimming (120Vac only) and 0-10V Dimming) |
| Driver Included: No   |
| Driver Location: Recessed Housing   |
| Driver Type: Constant Current - Universal   |
| Driver Class: Class 2   |
| Housing: See components   |
| Input Voltage (V): 120 - 277  |
| Constant Current (MA): 500  |

#### LED

|   |
|---|
| Number of LEDs: 1   |
| Color Temperature (°K): 2700 / 3000 / 3500 / 4000                       |
| Max. Delivered Lumen (lm): 940 / 980 / 1029 / 1050                      |
| Nominal Lumen (lm): 1386 / 1438 / 1511 / 1542                           |
| CRI: >90 CRI  |
| Efficiency (%): 87.9 / 88.4 / 87.9                                      |
| Lamp Life (hrs): 50000  |
| Upon Request: RGB-W Tunable White Special Color Temperature Special LED |

#### OPTICAL

|  |
|--|
| Reflector: 20 / 40 / 60                  |
| Adjustability: Rotational 355°; Tilt 10° |
| Upon Request: Special Beam Angles        |

#### RATINGS AND CERTIFICATIONS

Zaneen Group Inc. © 2024, T 1800-388-3382, F 416-247-9319, www.zaneen.com  
 Certified By: Certified for North American Standards  
 Available for International specifications by adding "INT" at the end of the existing Model #. For assistance on 'custom' specifications, contact zteam@zaneen.com.  
 IP Rating: IP20  
 If a conflict occurs to supply the best product, we reserve the right to change specifications or materials without notice. The most recent specification sheets are found at zaneen.com

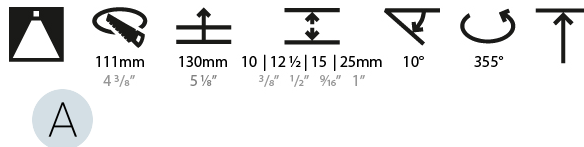
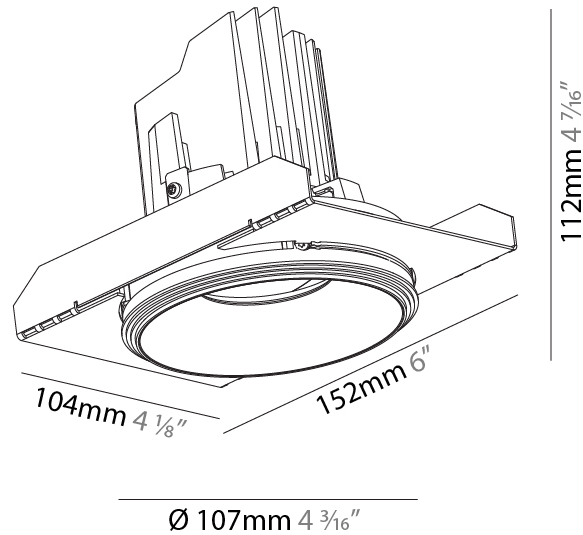

## BIONIQ ROUND SEMI ADJUSTABLE TRIMLESS

A35200-

PROJECT

TYPE

SPECIFIER

QUANTITY

DATE

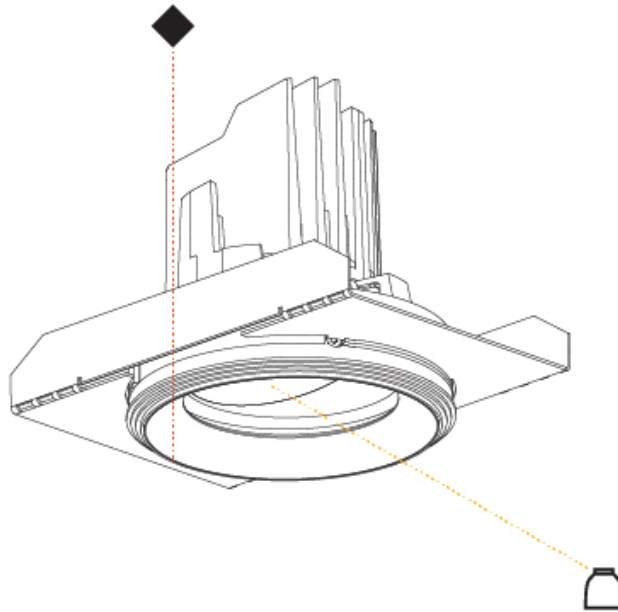



|           |  |
|-----------|--|
| PROJECT   |  |
| TYPE      |  |
| SPECIFIER |  |
| QUANTITY  |  |
| DATE      |  |

## BIONIQ ROUND SEMI ADJUSTABLE TRIMLESS

### A35203-

|             |             |           |           |
|-------------|-------------|-----------|-----------|
| base number | Color       | Finishes  | Ceiling   |
|             | Temperature | (Diamond) | Thickness |

- To build a product code in our configurator select the specify button on the base model # product page
- To build a manual product code on this datasheet choose from the options listed below in blue font and add the suffix to the base model #

#### GENERAL

Series: Bioniq  
 Subseries: Bioniq Round Semi Adjustable  
 Brand: Prolight  
 Division: Architectural  
 Mounting Type: Trimless  
 Mounting Location: Ceiling  
 Subcategory: Downlight

#### PHYSICAL

Shape: Round  
 Diameter (mm): 107  
 Diameter (in): 4 3/16  
 Height (mm): 112  
 Height (in): 4 7/16  
 Ceiling Thickness (mm): 10 / 12.5 / 15 / 25  
 Ceiling Thickness (in): 3/8 or 1/2 or 9/16 or 1  
 Min. Recessing Depth (mm): 130  
 Min. Recessing Depth (in): 5 1/8  
 Light Distribution: Adjustable / Downlight  
 Weight (kg): 0.624  
 Weight (lbs): 1.38  
 Fixture Finish: SSR / BKV / CWI / CRY / HAB / UFT / ITA / RUA / FTG / MYG / LOD / PUS / FRO / FUP / KIA / POP / BLS / SPG / MEY / GOH / GUM / CHC / COM / ABZ / JAG / OBR / MOS / ROR  
 Fixture Material: Aluminum Die Cast  
 Cut-out Measurements: 111mm / 4 3/8"  
 Upon Request: Unique Ceiling Thickness

#### ELECTRICAL

Lamp Type: LED (Zhaga Standard)  
 Input Wattage (W): 13.2 / 16.5  
 Total Output Wattage (W): 12.1 / 14.7  
 Dimming: Tri-Mode (Non-Dimming and Phase Dimming (120Vac only) and 0-10V Dimming)  
 Driver Included: No  
 Driver Location: Recessed Housing  
 Driver Type: Constant Current - Universal  
 Driver Class: Class 2  
 Housing: See components  
 Input Voltage (V): 120 - 277  
 Constant Current (MA): 350

#### LED

Number of LEDs: 1  
 Color Temperature (°K): 2700 / 3000 / 3500 / 4000  
 Max. Delivered Lumen (lm): 850 / 950 / 1019 / 1040  
 Nominal Lumen (lm): 960 / 1070 / 1156 / 1180  
 CRI: >90 CRI  
 Efficiency (%): 88.5  
 Lamp Life (hrs): 50000  
 Upon Request: RGB-W Tunable White Special Color Temperature Special LED

#### OPTICAL

Reflector°: 10  
 Adjustability: Rotational 355°; Tilt 10°  
 Upon Request: Special Beam Angles

#### RATINGS AND CERTIFICATIONS

Zaneen Group Inc. © 2024, T 1800-388-3382, F 416-247-9319, www.zaneen.com  
 Certified By: Certified for North American Standards  
 Available for International specifications by adding "INT" at the end of the existing Model #. For assistance on 'custom' specifications, contact zteam@zaneen.com.  
 IP Rating: IP20  
 If a conflict occurs to supply the best product, we reserve the right to change specifications or materials without notice. The most recent specification sheets are found at zaneen.com

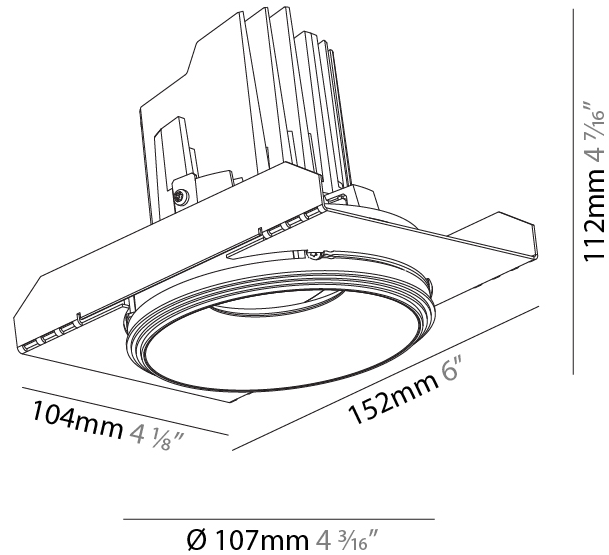

## BIONIQ ROUND SEMI ADJUSTABLE TRIMLESS

A35203-

PROJECT

TYPE

SPECIFIER

QUANTITY

DATE



|           |       |
|-----------|-------|
| PROJECT   | _____ |
| TYPE      | _____ |
| SPECIFIER | _____ |
| QUANTITY  | _____ |
| DATE      | _____ |

## BIONIQ ROUND SEMI ADJUSTABLE TRIMLESS

### A35209-

|             |             |                   |                    |                   |
|-------------|-------------|-------------------|--------------------|-------------------|
| base number | LED Dimming | Color Temperature | Finishes (Diamond) | Ceiling Thickness |
|-------------|-------------|-------------------|--------------------|-------------------|

- To build a product code in our configurator select the specify button on the base model # product page
- To build a manual product code on this datasheet choose from the options listed below in blue font and add the suffix to the base model #

#### GENERAL

Series: Bioniq  
 Subseries: Bioniq Round Semi Adjustable  
 Brand: Prolicht  
 Division: Architectural  
 Mounting Type: Trimless  
 Mounting Location: Ceiling  
 Subcategory: Downlight

#### PHYSICAL

Shape: Round  
 Diameter (mm): 136  
 Diameter (in): 5 3/8  
 Height (mm): 136  
 Height (in): 5 3/8  
 Ceiling Thickness (mm): 10 / 12.5 / 15 / 25  
 Ceiling Thickness (in): 3/8 or 1/2 or 9/16 or 1  
 Min. Recessing Depth (mm): 150  
 Min. Recessing Depth (in): 5 7/8  
 Light Distribution: Adjustable / Downlight  
 Weight (kg): 1.04  
 Weight (lbs): 2.29  
 Fixture Finish: SSR / BKV / CWI / CRY / HAB / UFT / ITA / RUA / FTG / MYG / LOD / PUS / FRO / FUP / KIA / POP / BLS / SPG / MEY / GOH / GUM / CHC / COM / ABZ / JAG / OBR / MOS / ROR  
 Fixture Material: Aluminum Die Cast  
 Cut-out Measurements: Ø 140mm / 5 1/2"  
 Upon Request: Unique Ceiling Thickness

#### ELECTRICAL

Lamp Type: LED (Zhaga Standard)  
 Input Wattage (W): 13.2 / 16.5  
 Total Output Wattage (W): 12.1 / 14.7  
 Dimming: Tri-Mode (Non-Dimming and Phase Dimming (120Vac only) and 0-10V Dimming)  
 Driver Included: No  
 Driver Location: Recessed Housing  
 Driver Type: Constant Current - Universal  
 Driver Class: Class 2  
 Housing: See components  
 Input Voltage (V): 120 - 277  
 Constant Current (MA): 350

#### LED

Number of LEDs: 1  
 Color Temperature (°K): 2700 / 3000 / 3500 / 4000  
 Max. Delivered Lumen (lm): 870 / 970 / 1038 / 1060  
 Nominal Lumen (lm): 960 / 1070 / 1156 / 1180  
 CRI: >90 CRI  
 Efficiency (%): 90.5  
 Lamp Life (hrs): 50000  
 Upon Request: RGB-W Tunable White Special Color Temperature Special LED

#### OPTICAL

Reflector°: 10  
 Adjustability: Rotational 355°; Tilt 10°  
 Upon Request: Special Beam Angles

#### RATINGS AND CERTIFICATIONS

Zaneen Group Inc. © 2024, T 1800-388-3382, F 416-247-9319, www.zaneen.com  
 Certified By: Certified for North American Standards  
 Available for International specifications by adding "INT" at the end of the existing Model #. For assistance on 'custom' specifications, contact zteam@zaneen.com.  
 IP Rating: IP20  
 If a conflict occurs to supply the best product, we reserve the right to change specifications or materials without notice. The most recent specification sheets are found at zaneen.com



Ø 136mm 5 3/8"



## BIONIQ ROUND SEMI ADJUSTABLE TRIMLESS

A35209-

PROJECT

TYPE

SPECIFIER

QUANTITY

DATE



A

|           |       |
|-----------|-------|
| PROJECT   | _____ |
| TYPE      | _____ |
| SPECIFIER | _____ |
| QUANTITY  | _____ |
| DATE      | _____ |

## BIONIQ ROUND WALLWASH RECESSED

### A37858-

|             |             |           |           |
|-------------|-------------|-----------|-----------|
| base number | Color       | Finishes  | Reflector |
|             | Temperature | (Diamond) | Options   |

- To build a product code in our configurator select the specify button on the base model # product page
- To build a manual product code on this datasheet choose from the options listed below in blue font and add the suffix to the base model #

#### GENERAL

|                                  |
|----------------------------------|
| Series: Bioniq                   |
| Subseries: Bioniq Round Wallwash |
| Brand: Prolicht                  |
| Division: Architectural          |
| Mounting Type: Recessed          |
| Mounting Location: Ceiling       |
| Subcategory: Downlight           |

#### PHYSICAL

|   |
|---|
| Shape: Round  |
| Diameter (mm): 139  |
| Diameter (in): 5 1/2  |
| Height (mm): 137  |
| Height (in): 5 3/8  |
| Ceiling Thickness (mm): 10 / 12.5 / 15 / 25   |
| Ceiling Thickness (in): 3/8 or 1/2 or 9/16  |
| Min. Recessing Depth (mm): 150  |
| Min. Recessing Depth (in): 5 7/8  |
| Light Distribution: Adjustable / Asymmetric   |
| Weight (kg): 0.865  |
| Weight (lbs): 1.9   |
| Fixture Finish: SSR / BKV / CWI / CRY / HAB / UFT / ITA / RUA / FTG / MYG / LOD / PUS / FRO / FUP / KIA / POP / BLS / SPG / MEY / GOH / GUM / CHC / COM / ABZ / JAG / OBR / MOS / ROR |
| Fixture Material: Aluminum Die Cast   |
| Cut-out Measurements: 130mm / 5 1/8"  |

#### ELECTRICAL

|   |
|---|
| Lamp Type: LED (Zhaga Standard)   |
| Input Wattage (W): 28.6   |
| Total Output Wattage (W): 26  |
| Dimming: Tri-Mode (Non-Dimming and Phase Dimming (120Vac only) and 0-10V Dimming) |
| Driver Included: No   |
| Driver Location: Recessed Housing   |
| Driver Type: Constant Current - Universal   |
| Housing: See components   |
| Input Voltage (V): 120 - 277  |
| Constant Current (MA): 700  |

#### LED

|  |
|--|
| Number of LEDs: 1                                    |
| Color Temperature (°K): 2700 / 3000 / 3500 / 4000    |
| Max. Delivered Lumen (lm): 1890 / 1930 / 2028 / 2070 |
| Nominal Lumen (lm): 3210 / 3290 / 3459 / 3530        |
| CRI: >90 CRI   |
| Lamp Life (hrs): 50000                               |

#### OPTICAL

|                          |
|--------------------------|
| Reflector°: 20 / 25 / 40 |
| Adjustability: Fixed     |

#### RATINGS AND CERTIFICATIONS

|  |
|--|
| Certified By: Certified for North American Standards |
| IP rating: IP20                                      |



Ø 65mm 2 5/16"

Ø 139mm 5 1/2"



## BIONIQ ROUND WALLWASH RECESSED

A37858-

PROJECT

TYPE

SPECIFIER

QUANTITY

DATE



A

|           |
|-----------|
| PROJECT   |
| TYPE      |
| SPECIFIER |
| QUANTITY  |
| DATE      |

### Fixture Finish



**Digital:** Not all screens are calibrated the same, and therefore, colors will appear differently between screens.

**Physical:** When texture is involved, there will be variations in color, character and tone within a product series and between product families.

**Gun Metal:** No Gun Metal finish is alike. It combines a mixture of transparent and black color particles which ensures a highly individual effect and no luminaire being identical.





































































**Champagne Cream, Copper Mine, Ancient Bronze + Jazz Gold:** These finishes have slight fading from specific powder coating production. Each luminaire will slightly vary.





|           |  |
|-----------|--|
| PROJECT   |  |
| TYPE      |  |
| SPECIFIER |  |
| QUANTITY  |  |
| DATE      |  |











### LEGEND

|  |   |   |  |   |  |
|--|---|---|--|---|--|
|    | floor-mounted   |    | pivotal  |    | special LED (upon request) RGB, RGBW, tunable, gold+, meat+, art+, fashion+                    |
|    | wall and ceiling: recessed and surface mounted            |    | rotating   |    | warm dim / natural dimming LED   |
|    | ceiling-mounted and wall-mounted                          |    | illuminate tilted  |    | rechargeable battery powered   |
|    | wall-mounted  |    | color of suspension cable                                    |    | fixture with natural vivid LED (upon request)  |
|    | omni-directional light distribution                       |    | length of suspension cable                                   |    | color rendering index  |
|    | direct light distribution                                 |    | reflector degree selection                                   |    | color temperature  |
|    | direct/indirect light distribution                        |    | super spot   |    | lumen (luminous flux)  |
|    | indirect light distribution                               |    | lens   |    | efficacy (lumens per watt)   |
|    | asymmetric light distribution                             |    | lens pack  |    | Unified Glare Rating (UGR) range from 5-40   |
|    | aura light distribution                                   |    | shine ring   |    | marine grade (AISI 316 stainless steel)  |
|    | round wall or ceiling cut-out                             |    | integrated shine ring with diffuser                          |    | walk on  |
|    | square wall or ceiling cut-out                            |    | free individual colors 01-29                                 |    | drive on   |
|    | the supplied jig specifies the cutout dimensions          |    | individual colors: 00 (free of charge), 01-25 (extra charge) |    | Dark Sky Compliance  |
|    | minimum distance (meters) lamp - object                   |    | luminaire part to be colored (F1)                            |    | Americans with Disabilities Act (less than 4" off the wall located between 27"-84" from floor) |
|    | recessed depth  |    | luminaire part to be colored (F2)                            |    | lamp protected against explosion   |
|    | ceiling thickness in mm                                   |    | luminaire part to be colored (F3)                            |    | blown glass using traditional methods by master glass blower                                   |
|   | ceiling thickness selection                               |   | luminaire part to be colored (F4)                            |   | acoustic material  |
|  | dimnable DP (phase), DV (0-10V), DD (dali), DS (step-dim) |  | luminaire part to be colored (F5)                            |  | protection class I, protection insulation  |
|  | included or excluded LED driver/transformer/control gear  |  | color of 3-circuit adaptor                                   |  | protection class II, protection insulation   |
|  | separately switchable                                     |  | indirect diffuser  |  | ETL Certified to UL and CSA Standards  |
|  | sensor  |  | direct diffuser  |  | UL Certified to UL and CSA Standards   |
|  | remote control  |  | ball-proof (upon request)                                    |  | CSA Certified to UL and CSA Standards  |
|  | available upon request                                    |  | accessory  |  | Certified for North American Standards   |

### IP RATING

|   |  |
|---|--|
|  | protected against ingress of solid bodies greater than 12.5mm (finger)   |
|  | protected against ingress of solid bodies greater than 2.5mm<br>protected against sprays of water up to 60 degrees from the vertical (rain)      |
|  | protected against ingress of solid bodies greater than 1mm (wire)<br>no protection against the ingress of moisture                               |
|  | protected against ingress of solid bodies greater than 1mm (wire)<br>protected against sprays of water up to 60 degrees from the vertical (rain) |
|  | protected against ingress of solid bodies greater than 1mm (wire)<br>protected against water splashed from all directions                        |
|  | protected against limited ingress of dust (wet rooms/covered outdoor areas)<br>protected against water splashed from all directions              |
|  | protected against ingress of dust<br>protected against jets of water   |
|  | protected against ingress of dust<br>protected against powerful jets of water or heavy seas  |
|  | protected against ingress of dust<br>protected against immersion of water between 15cm - 1m for 30 minutes                                       |
|  | protected against ingress of dust<br>protected against immersion of water under pressure for long periods  |

### IK RATING

|   |   |
|---|---|
|  | protected against 0.14 joules impact (equivalent to 0.25kg mass dropped from 56mm above the surface)  |
|  | protected against 0.2 joules impact (equivalent to 0.25kg mass dropped from 80mm above the surface)   |
|  | protected against 0.35 joules impact (equivalent to 0.25kg mass dropped from 140mm above the surface) |
|  | protected against 0.5 joules impact (equivalent to 0.25kg mass dropped from 200mm above the surface)  |
|  | protected against 0.7 joules impact (equivalent to 0.25kg mass dropped from 280mm above the surface)  |
|  | protected against 1 joules impact (equivalent to 0.25kg mass dropped from 400mm above the surface)    |
|  | protected against 2 joules impact (equivalent to 0.5kg mass dropped from 400mm above the surface)     |
|  | protected against 5 joules impact (equivalent to 1.7kg mass dropped from 300mm above the surface)     |
|  | protected against 10 joules impact (equivalent to 5.0kg mass dropped from 200mm above the surface)    |
|  | protected against 20 joules impact (equivalent to 5.0kg mass dropped from 400mm above the surface)    |